

0 603 391 780

Stand 105-41
Issue 13-12-04

Fig. /Abb. 2

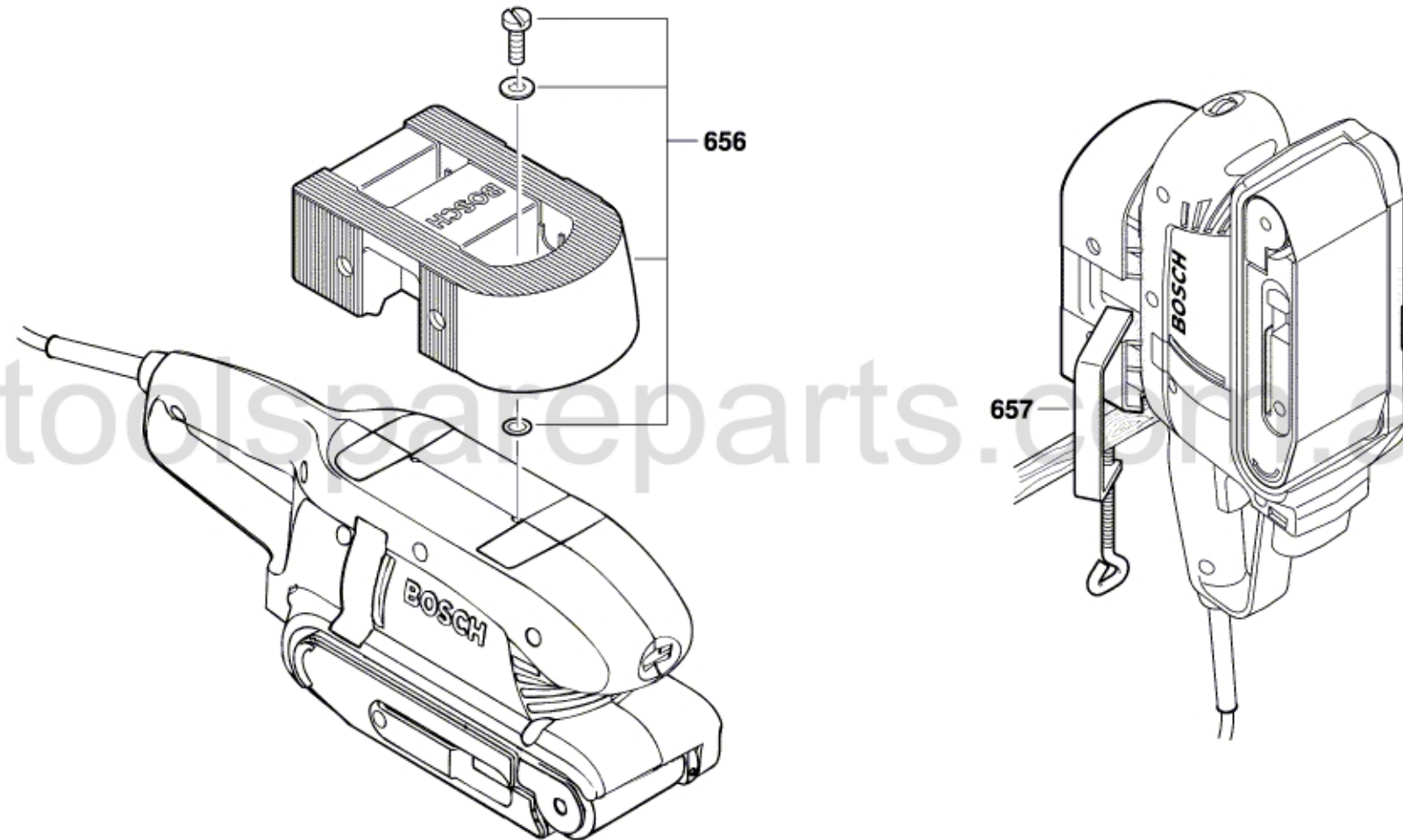

Änderungen vorbehalten
Modifications reserved
Modificacions reserves
Salvo modificaciones